

# DAVIN

## Typ F

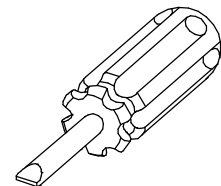

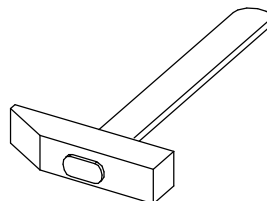

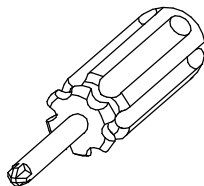
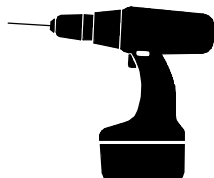
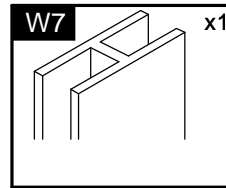
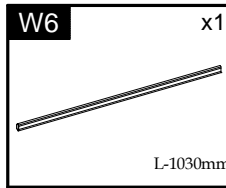
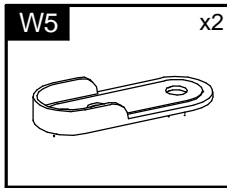
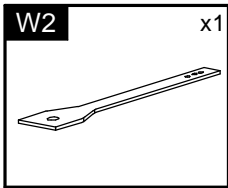
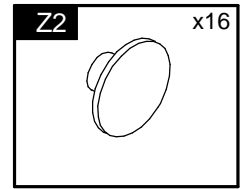
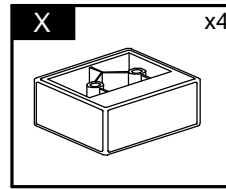
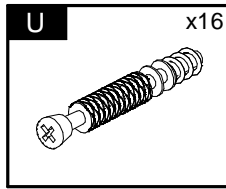
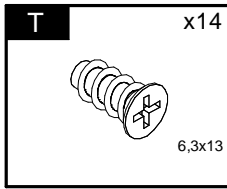
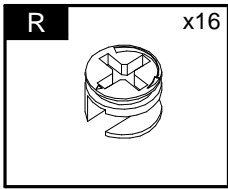
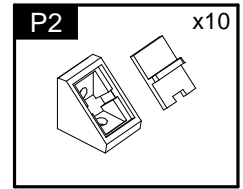
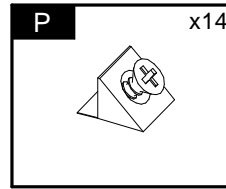
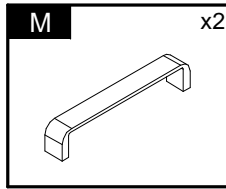
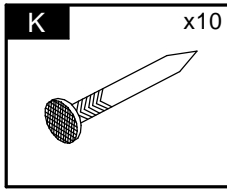
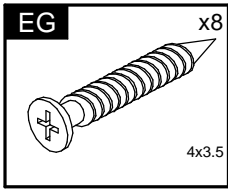
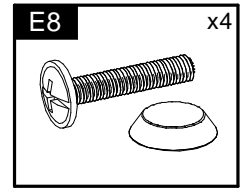
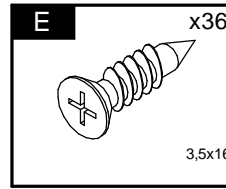
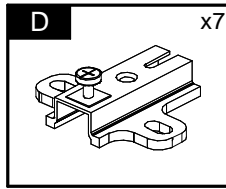
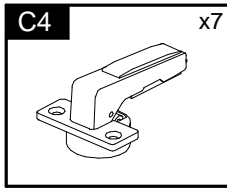
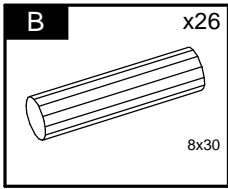

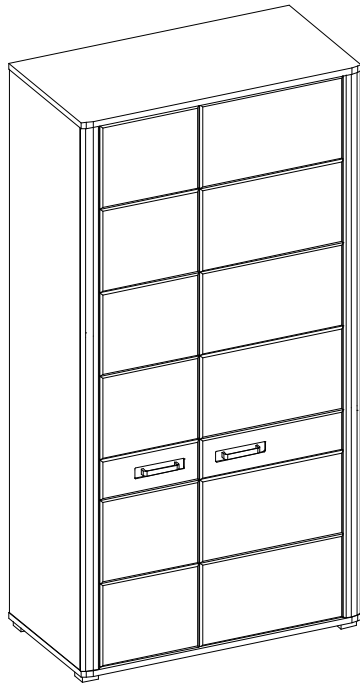

Element symbol	Measurements				Code	Paket
1	1069	560	22	1	1001	1/2
2	1069	560	22	1	1002	1/2
3	2036	538	16	1	1003	1/2
4	2036	538	16	1	1004	1/2
5	1035	524.5	16	1	1030	1/2
6	1035	100	16	1	1031	1/2
7	2050	524	2.5	2	N/A	2/2
8	2036	68	19	1	1017	2/2
9	2036	68	19	1	1029	2/2
10	2031	377	19	1	3032	2/2
11	2031	547	19	1	3033	2/2

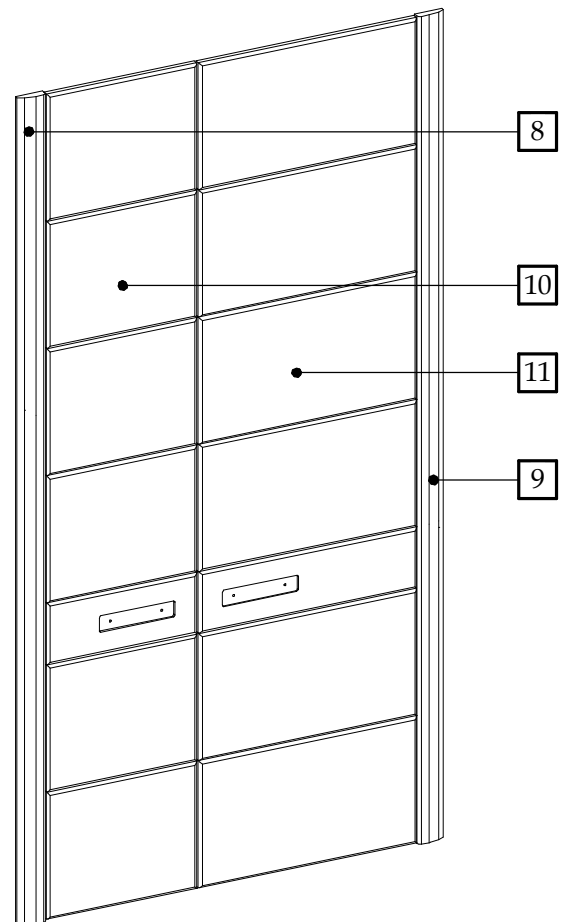
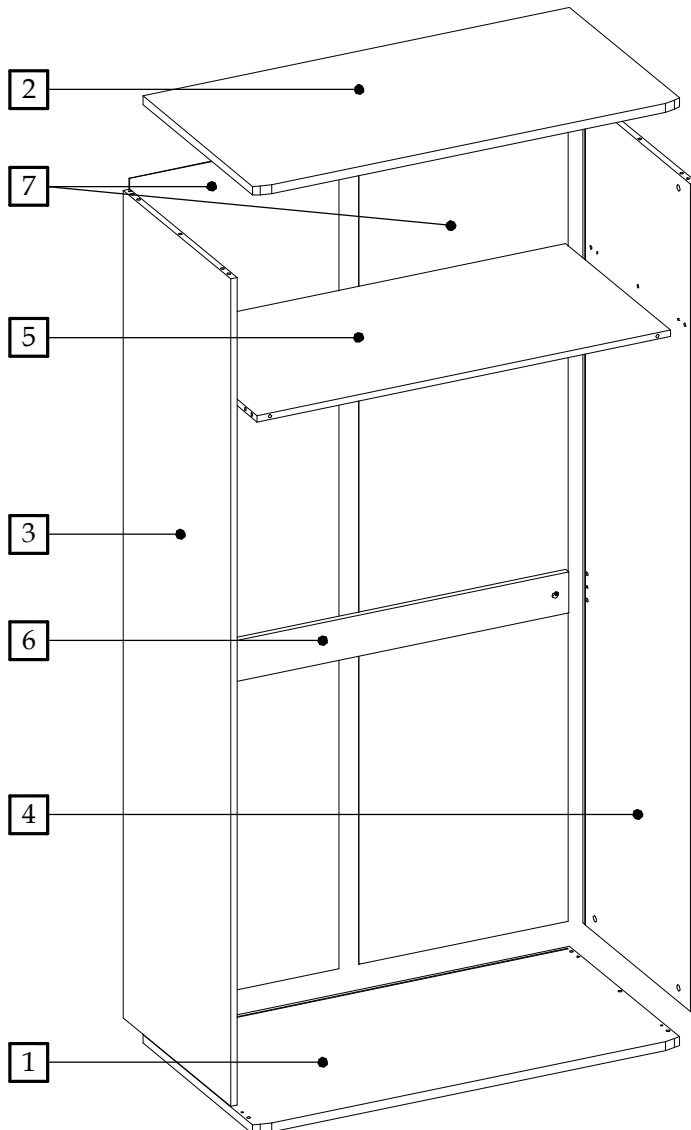

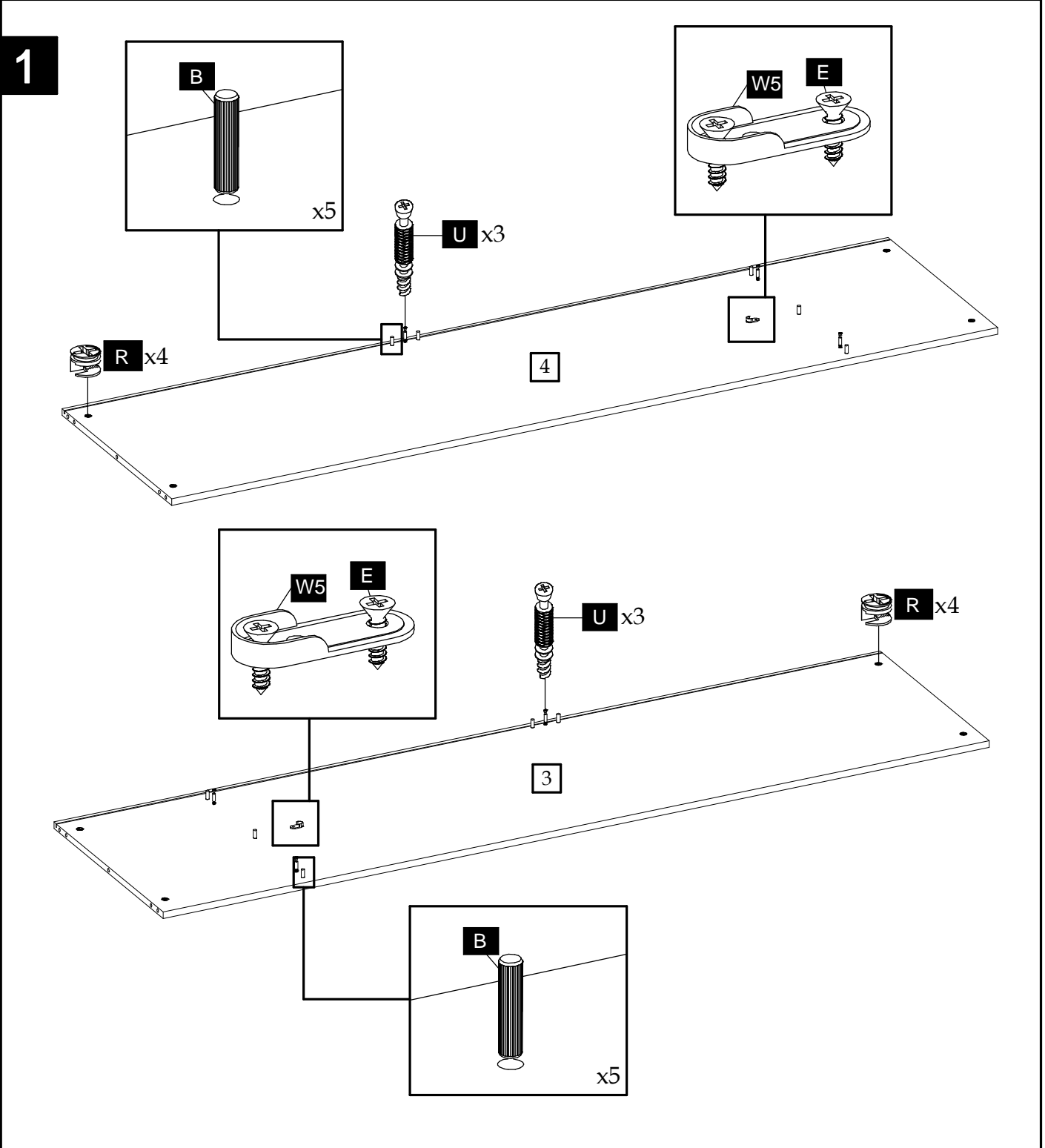

2

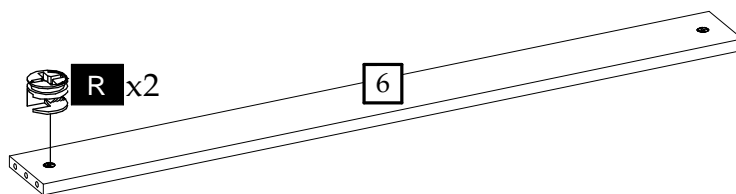
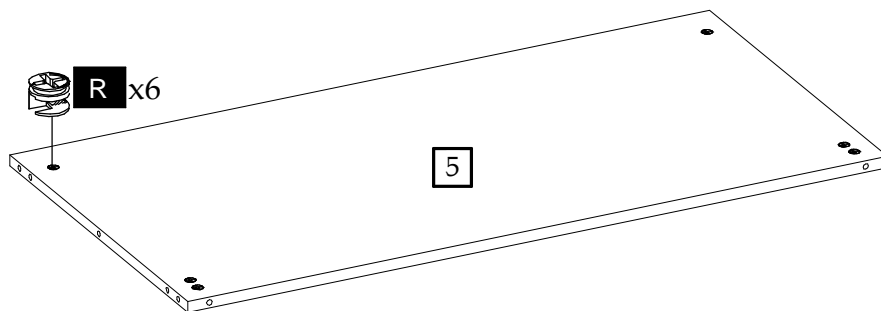

3

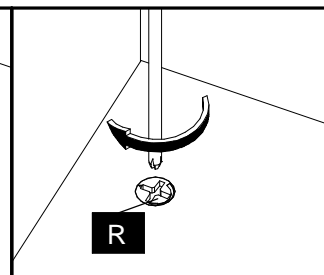
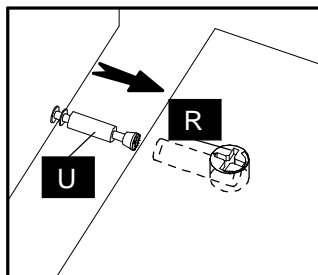
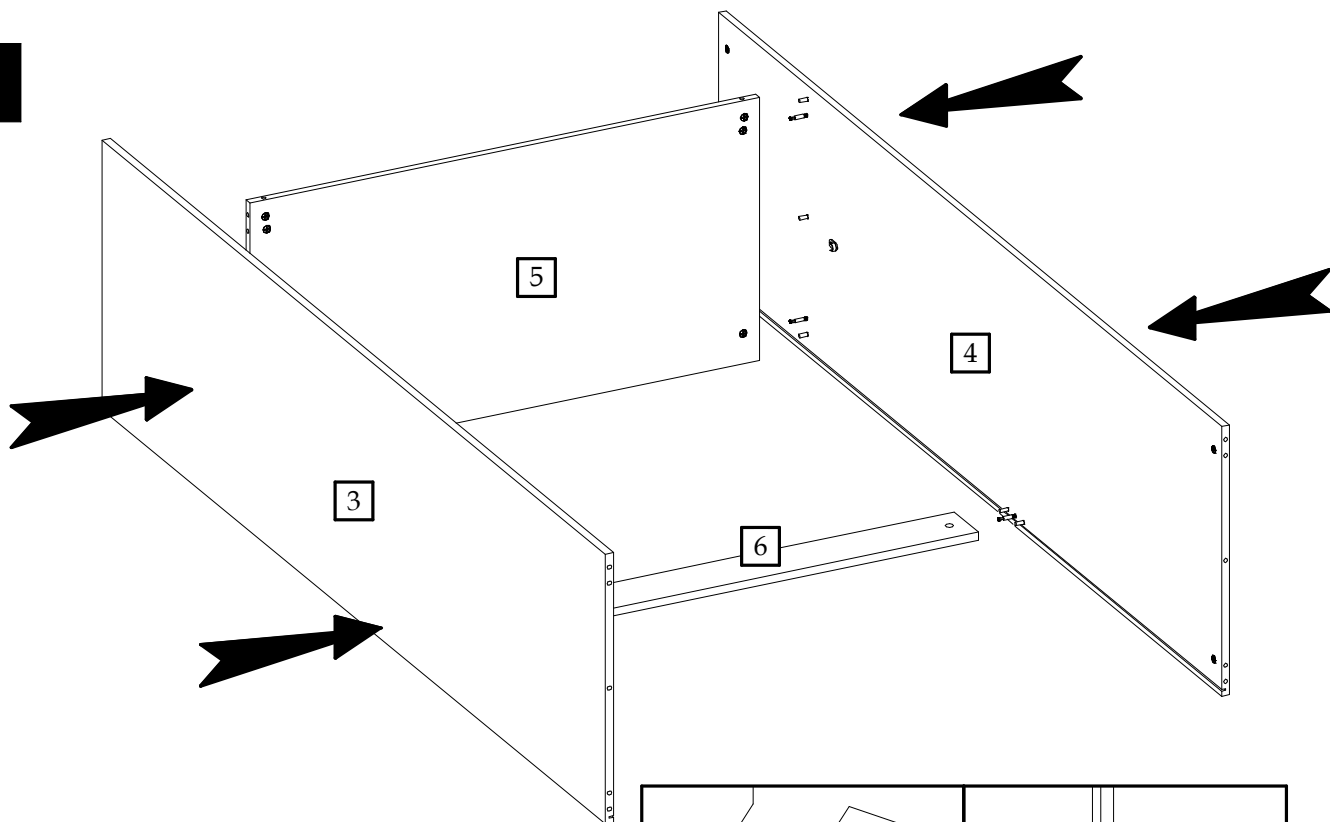

4

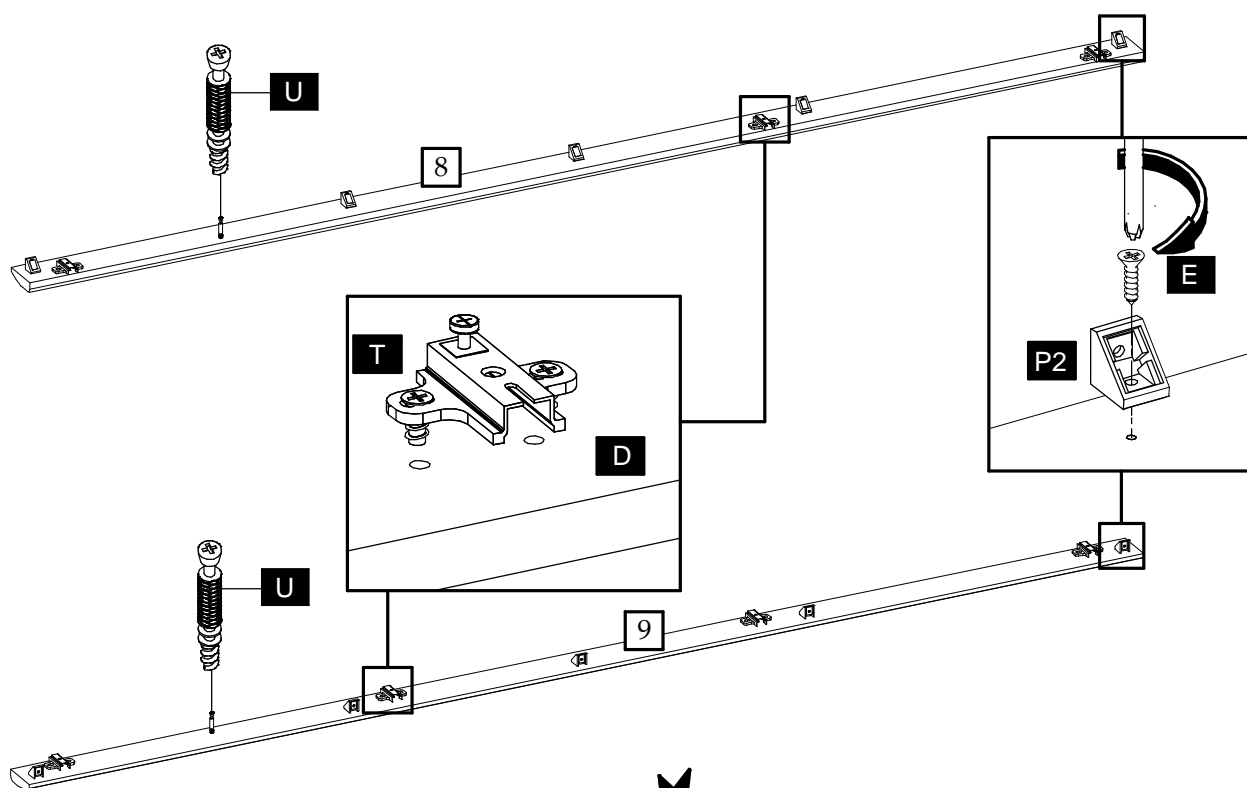

5

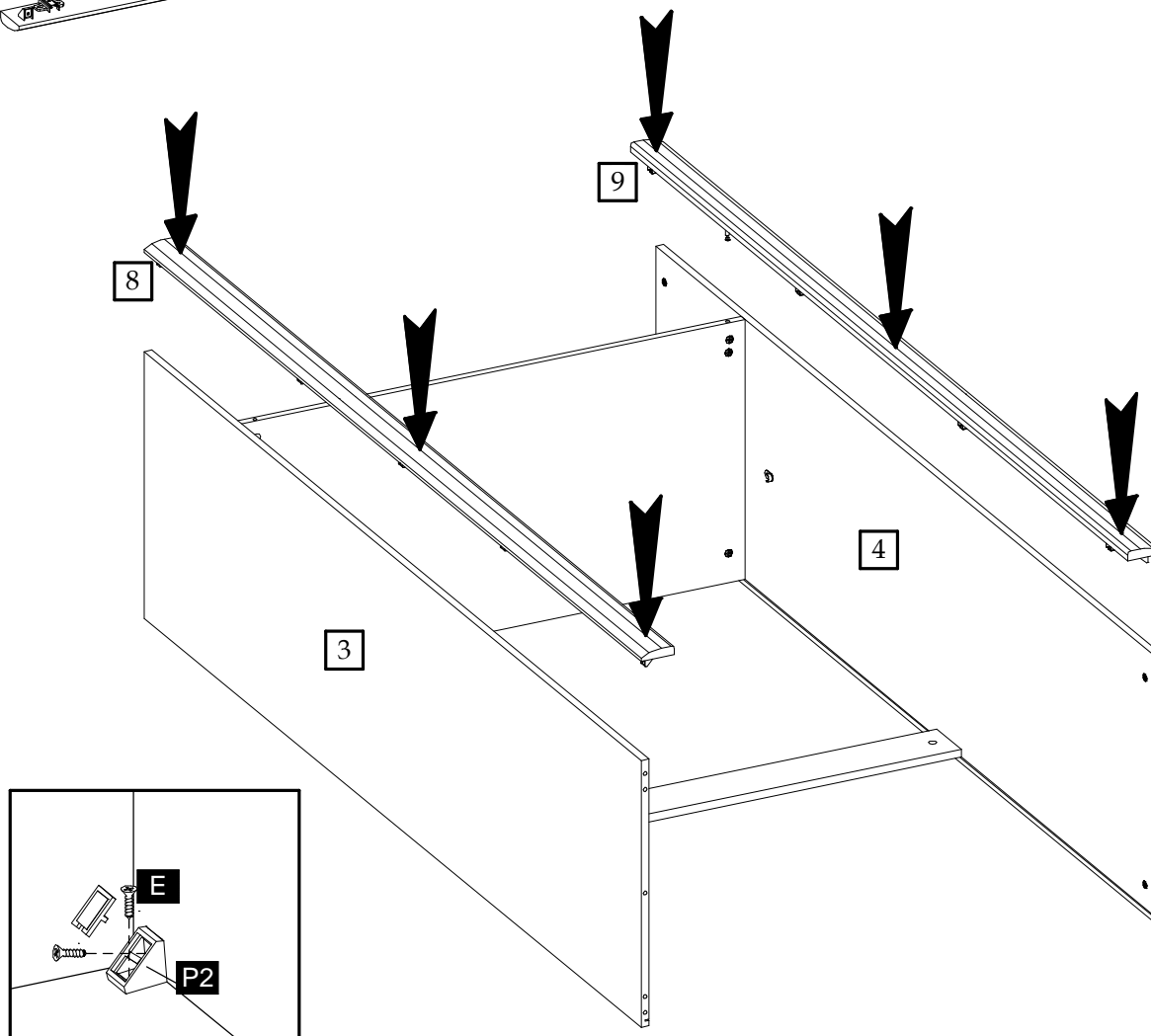

6

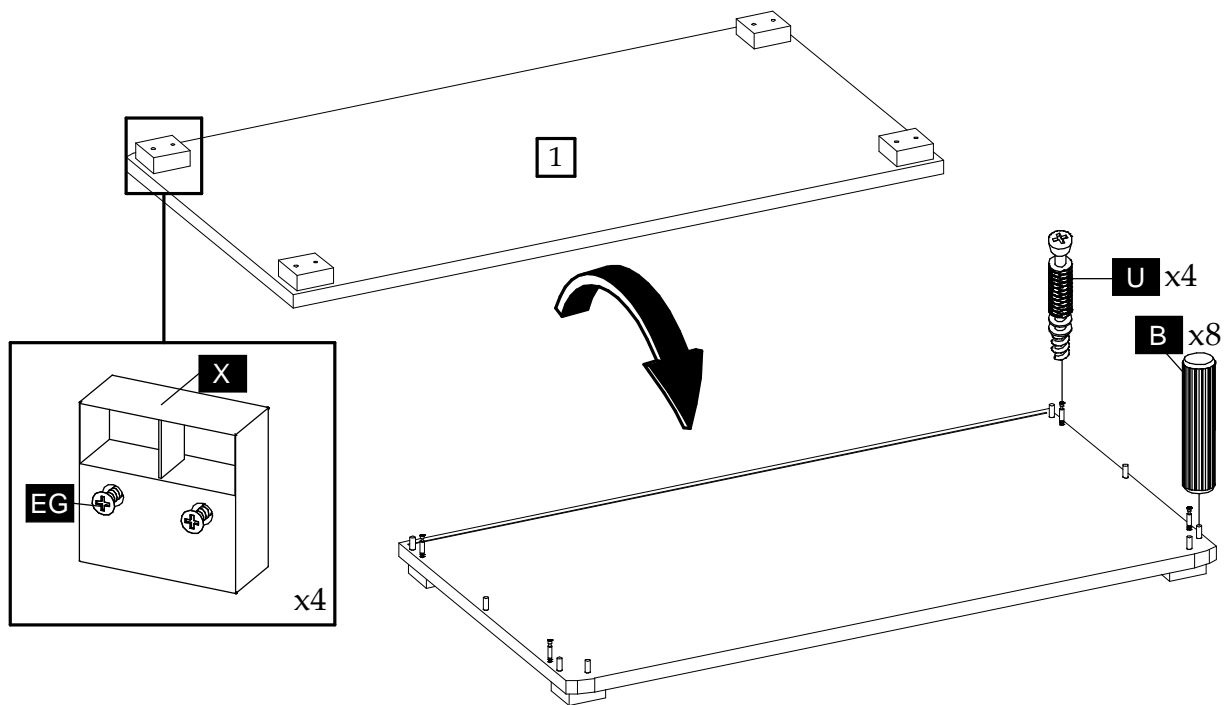

7

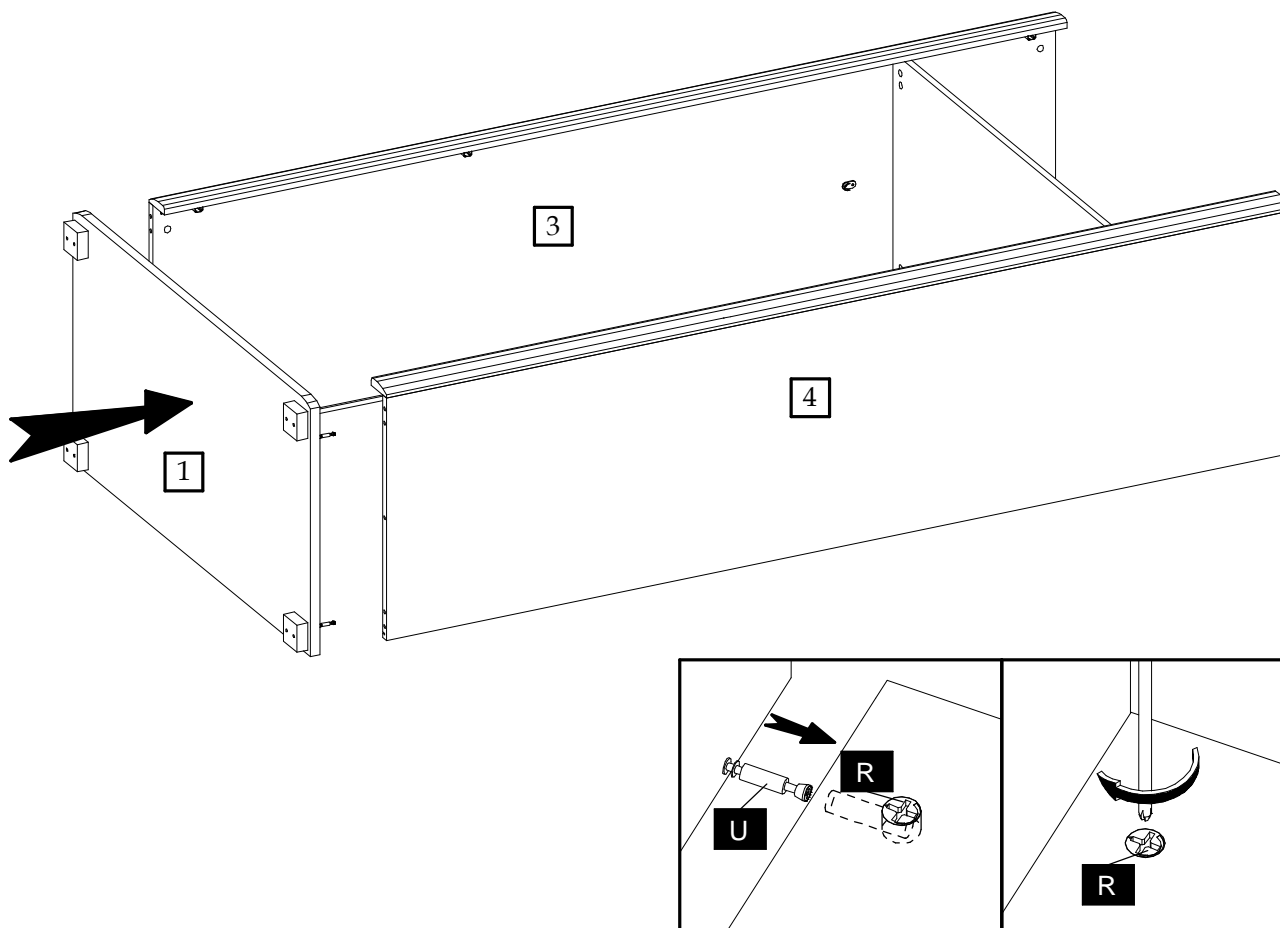



8

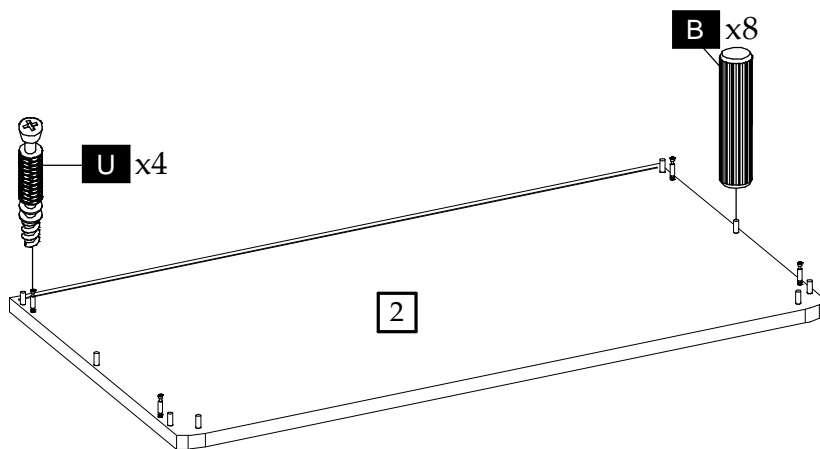

9

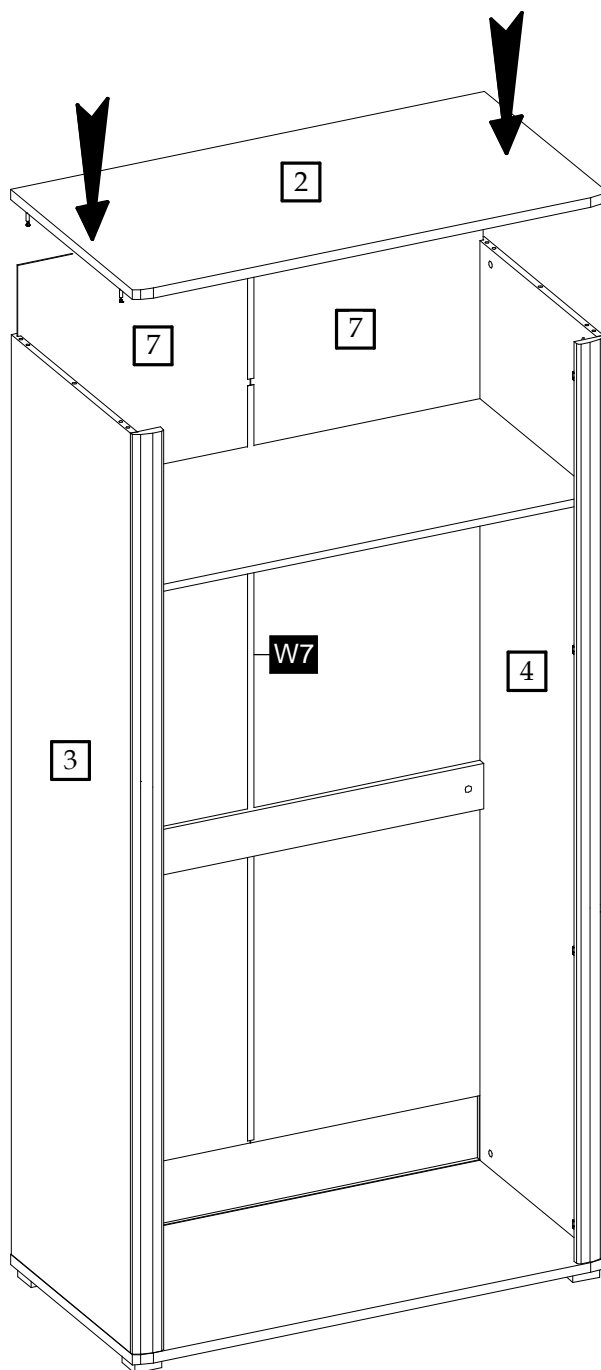

10

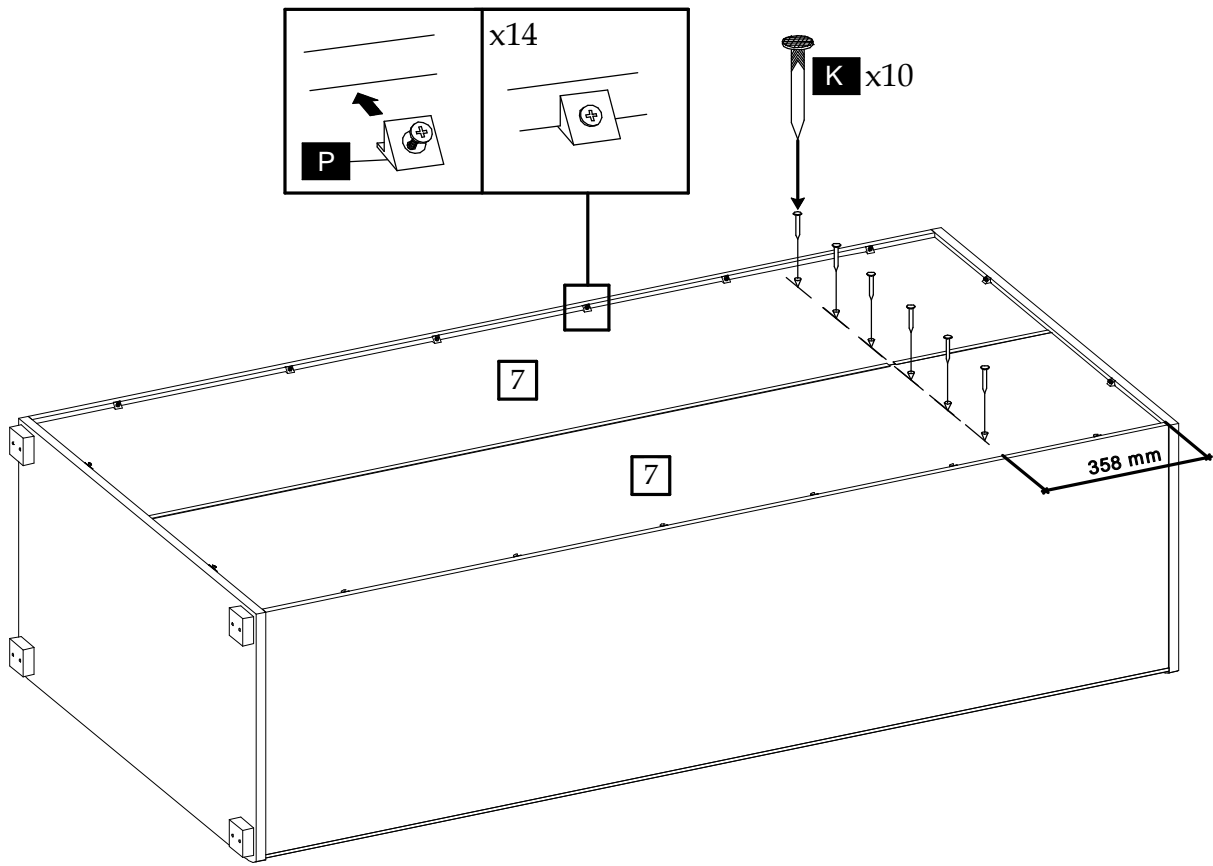

11

