

A	B	C (mm)	D
1	S220-0001	2100	526
2	S220-1001	2048	540
3	S220-1002	2048	540
4	S220-1003	2048	520
5	S220-2001	1696	540
6	S220-2002	1696	540
7	S220-3001	559	520
8	S220-3002	1088	520
9	S220-3003	558	505
10	S220-5502	400	179
11	S220-7001	2100	596
12	S220-7004	100	336
13	S220-9301	2058	573
14	S220-9302	2058	1099
15	dr-1085	1085	30

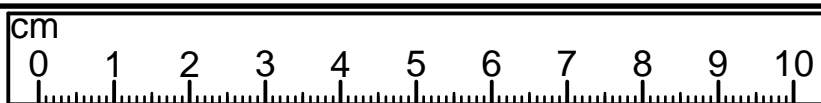

8x 95° cichy domyk a108	4x a109	12x D1.9 b51	12x Ø5x17 mm d1	9x Ø7x50 mm e1	16x Ø8x30 mm f1	2x Ø8x50 mm f6	2x k53	4x 84x40/25 mm k77	17x l1	28x l2	2x h=22mm n1	14x 20x13x3.5/1 n108
16x Ø5.3/Ø8.3x4.8 mm o54	2x Ø3.5x13 mm p1	10x Ø4x25 mm p36	18x Ø3.5x16 mm p38	24x Ø3.5x15 mm p51	14x Ø2.9x16 mm p55	15x Ø15x12 mm #16 r1	6x Ø15x15 mm #22 r3	3x 36/20 mm r28	15x r42	21x Ø16 s2	1x z1	2x n26/1

1 

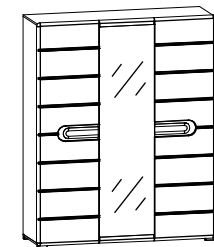
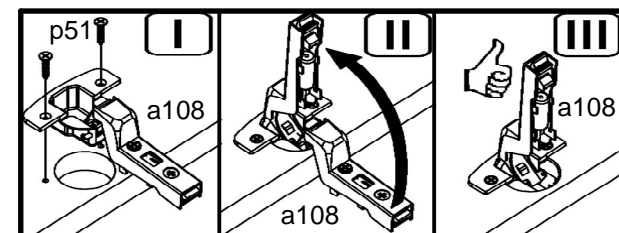
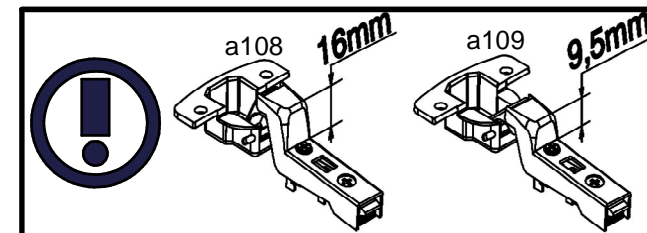
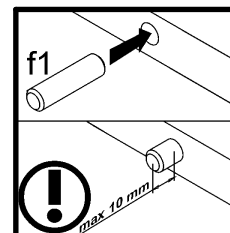
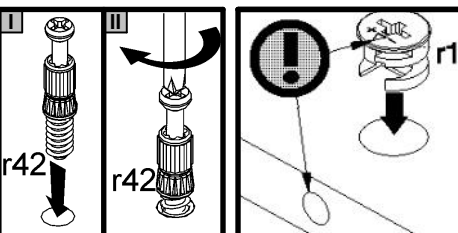
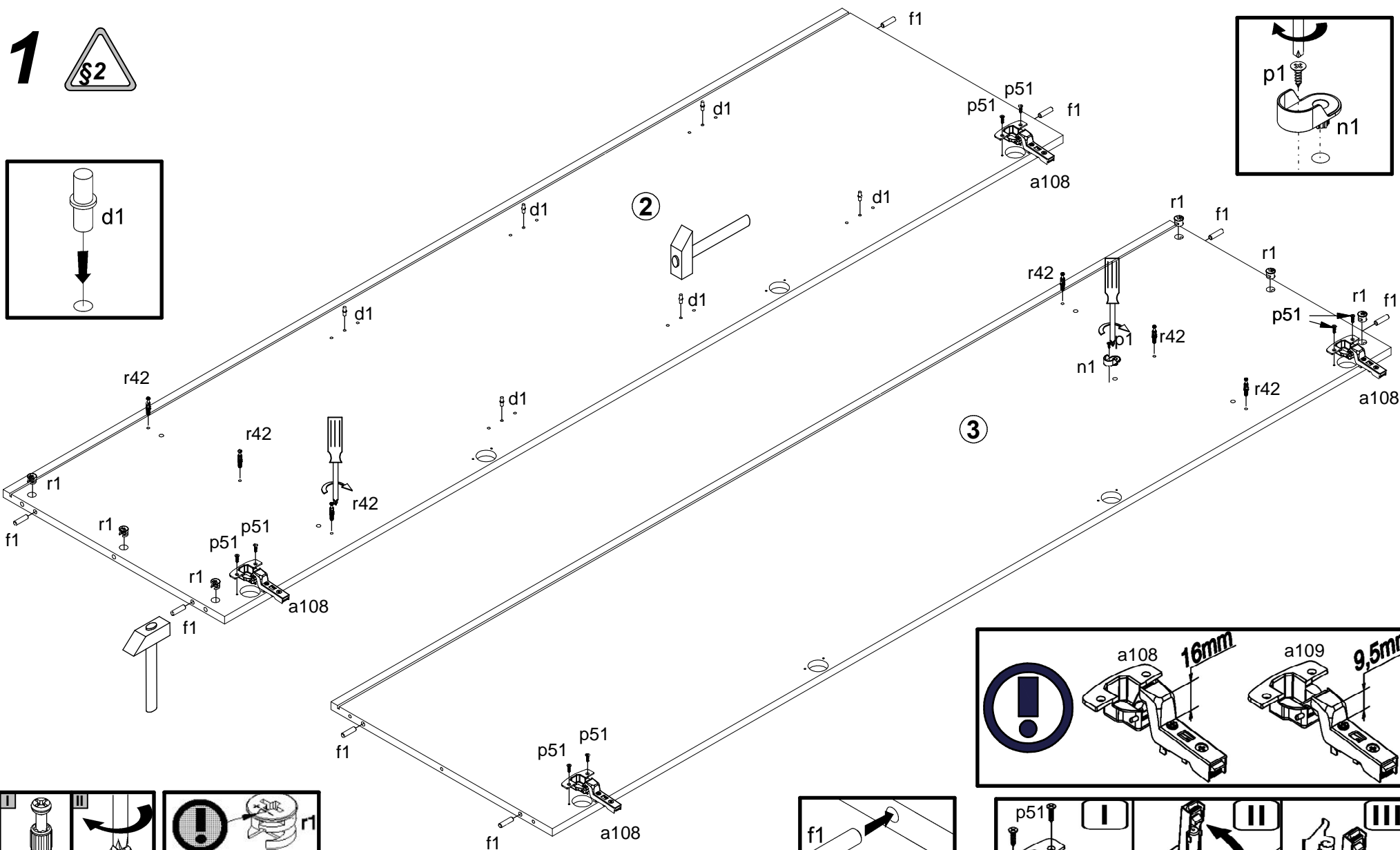
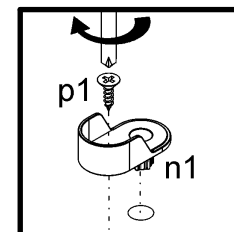
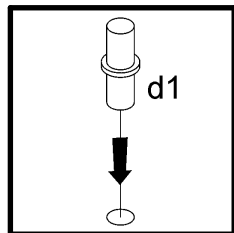

1

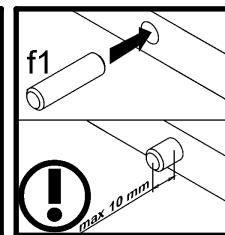
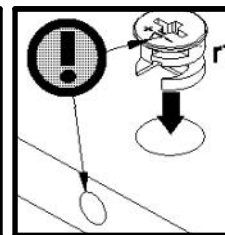
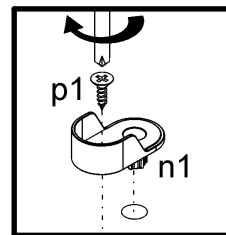
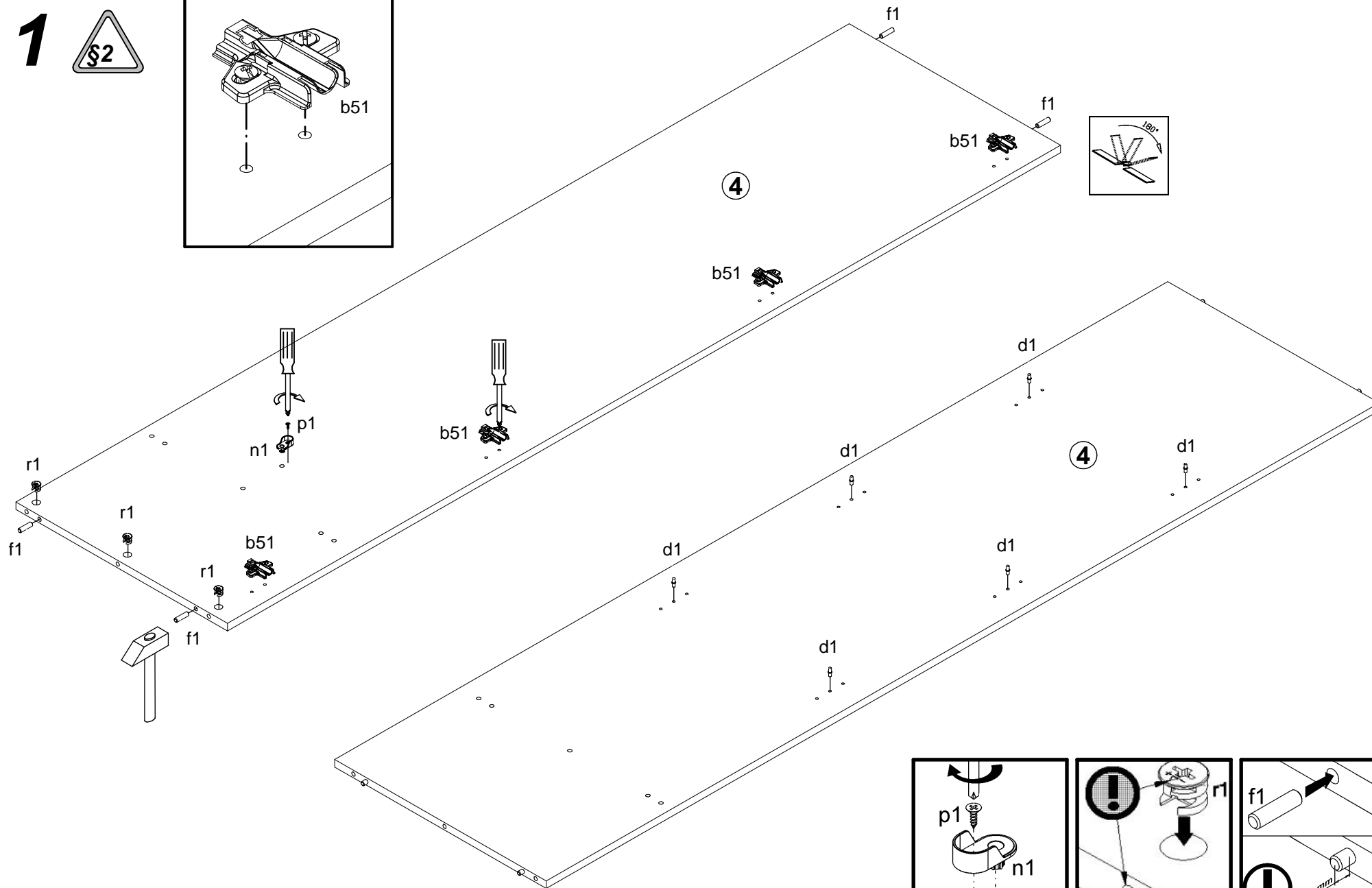
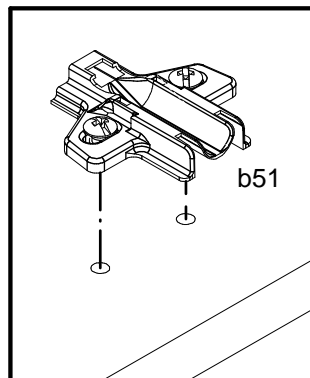

1 

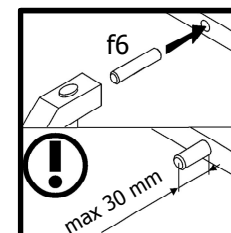
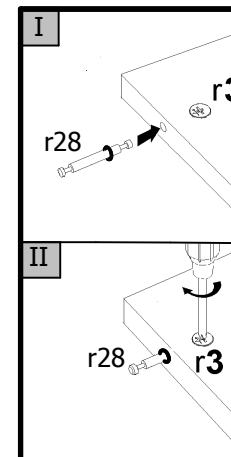
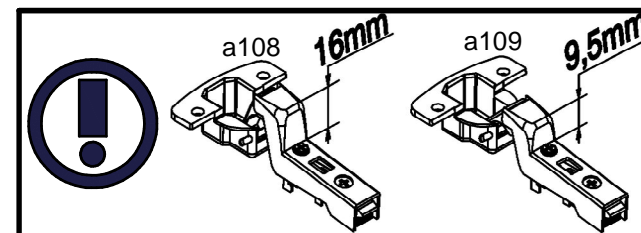
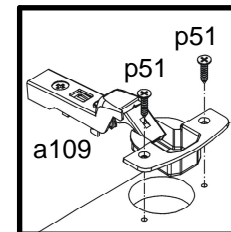
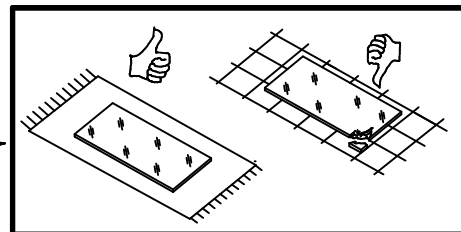
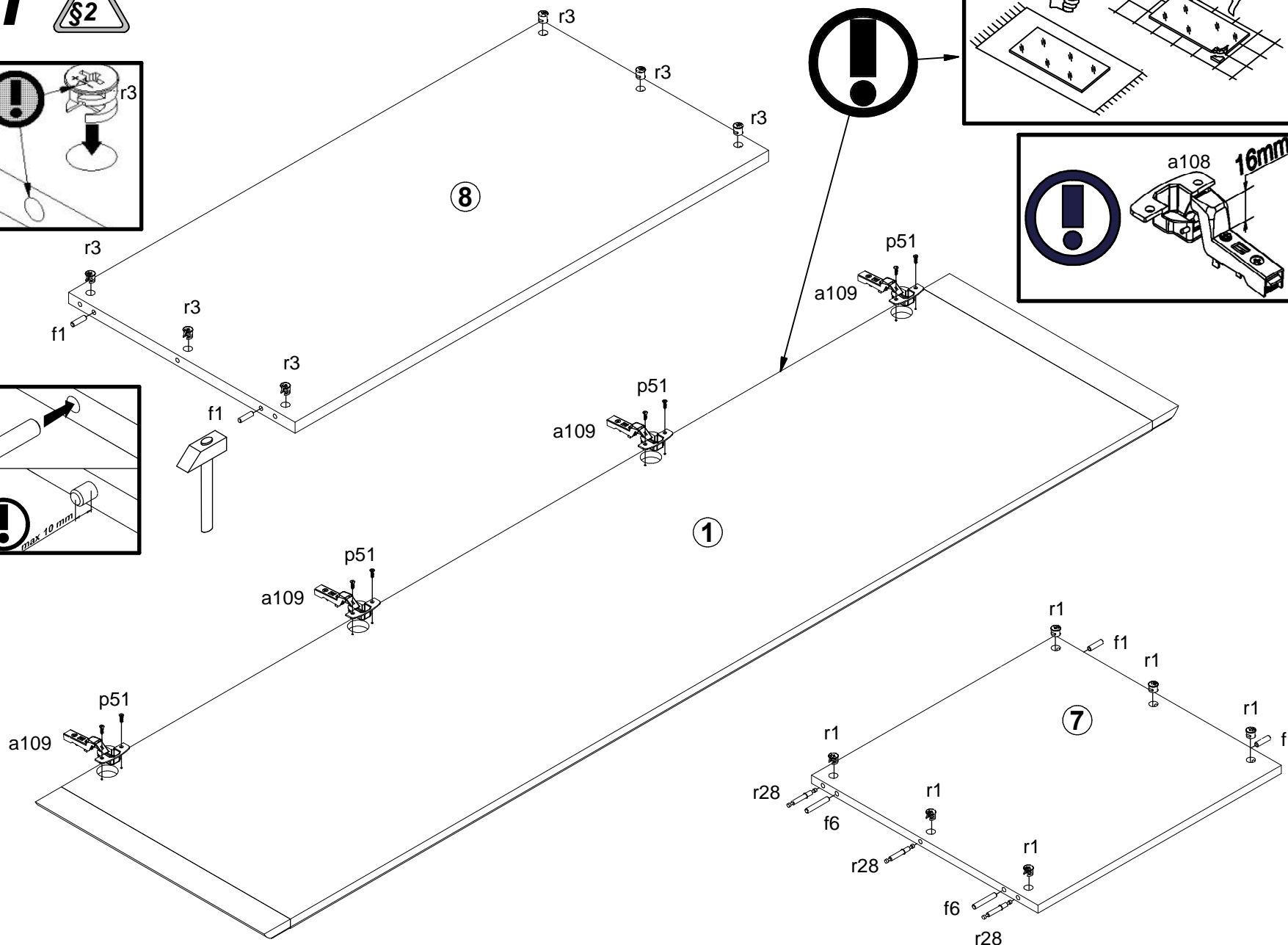
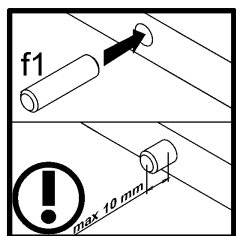
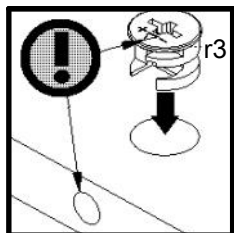

1

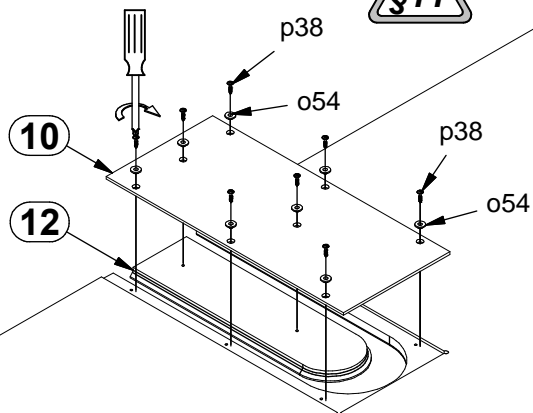
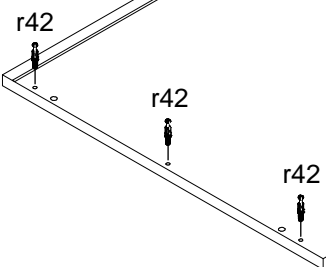
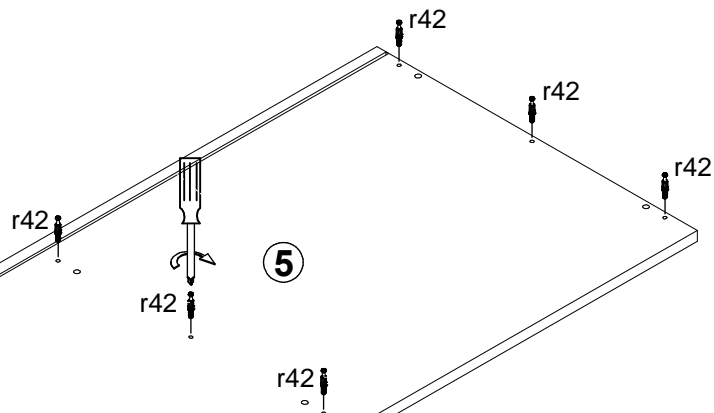
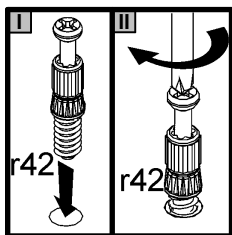

11

b51

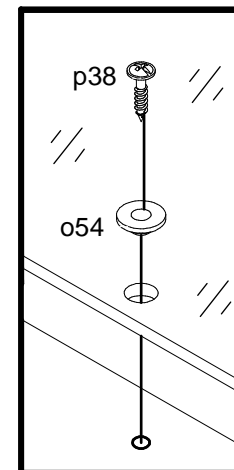
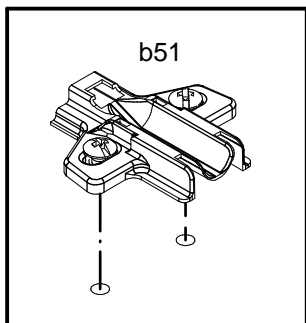

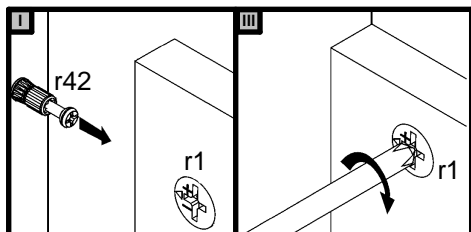
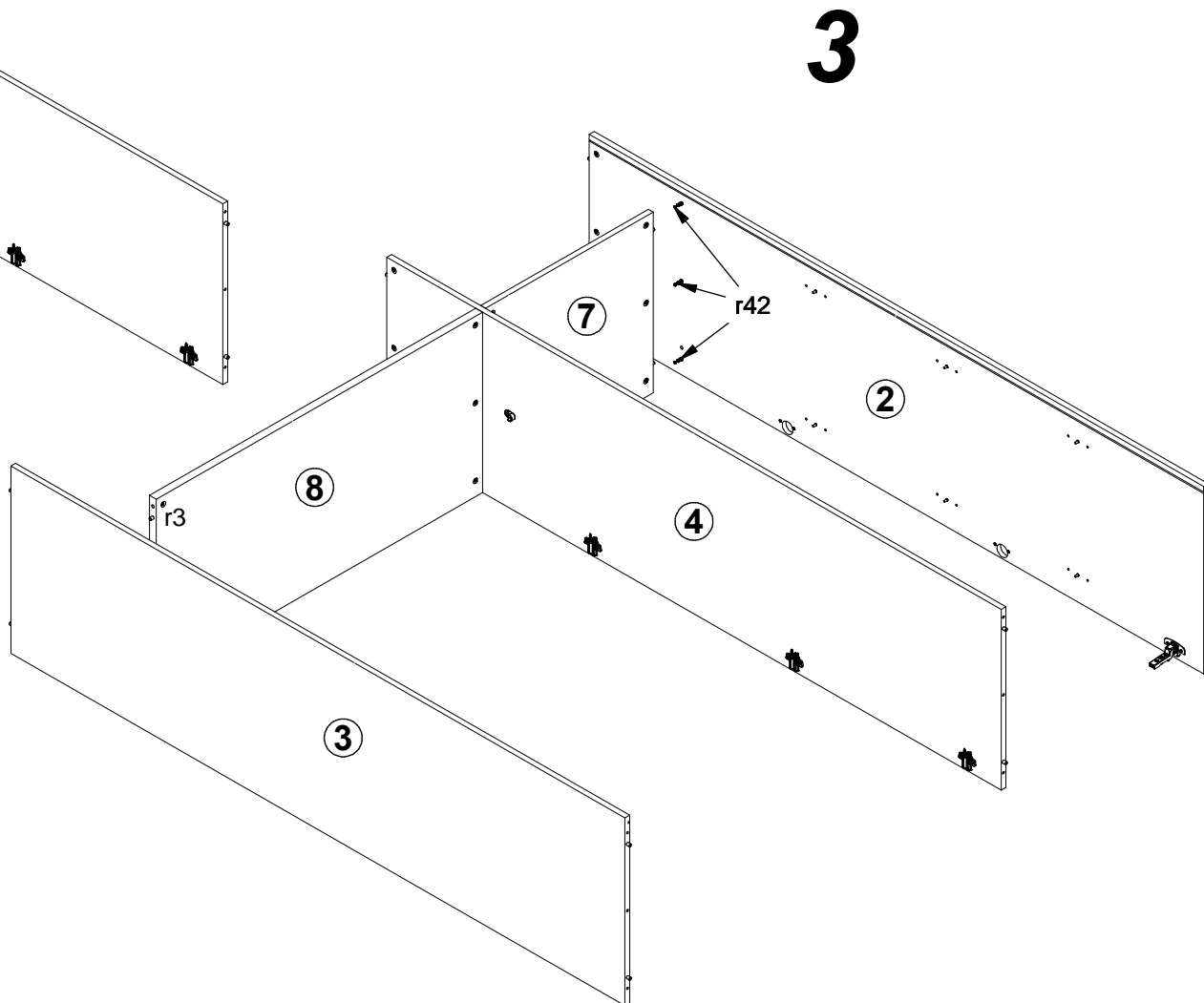
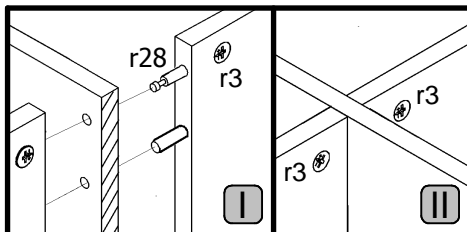
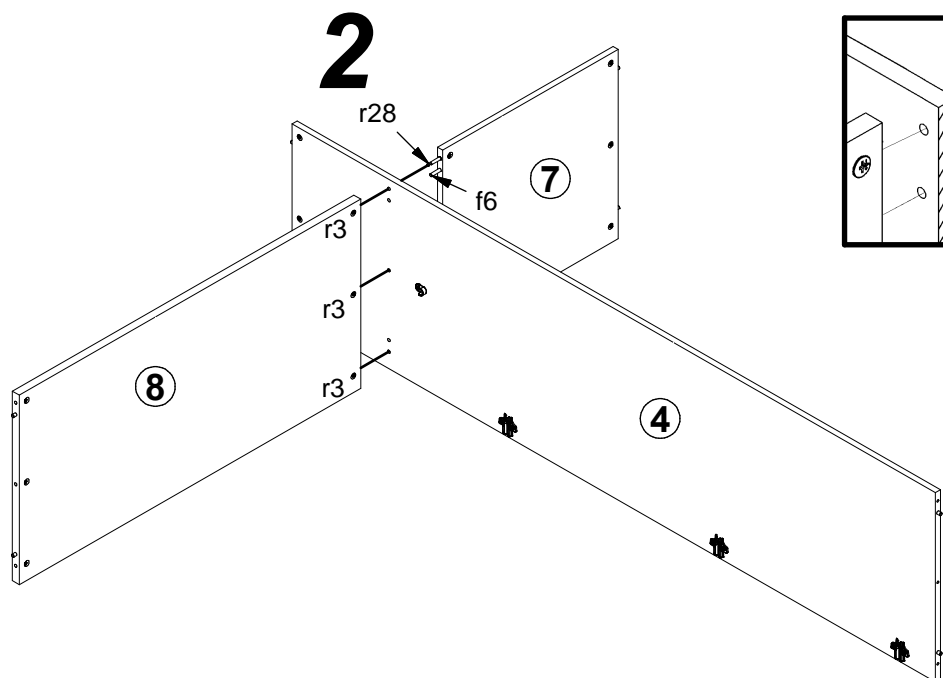

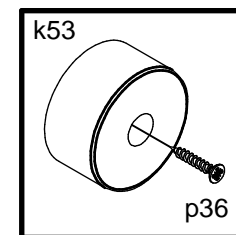
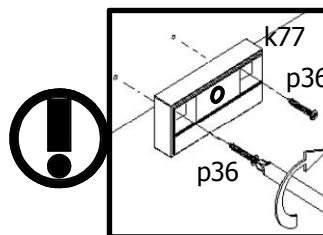
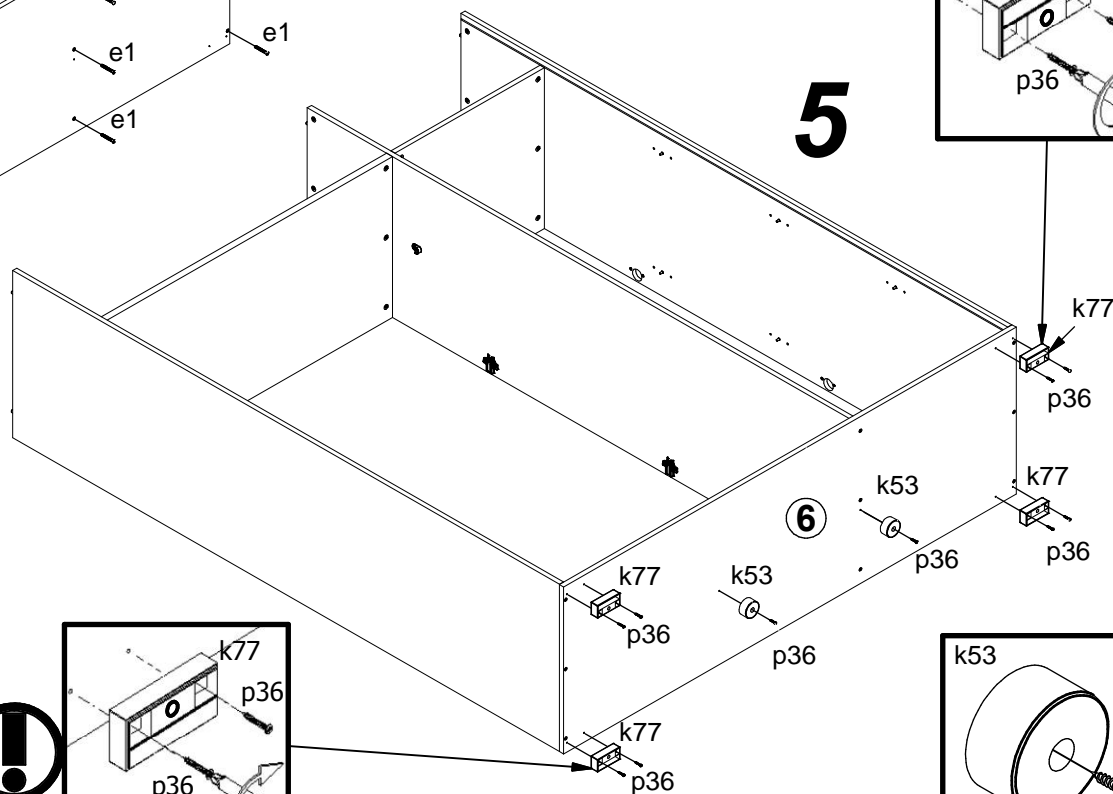
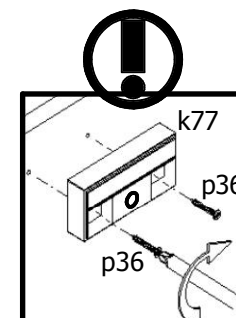
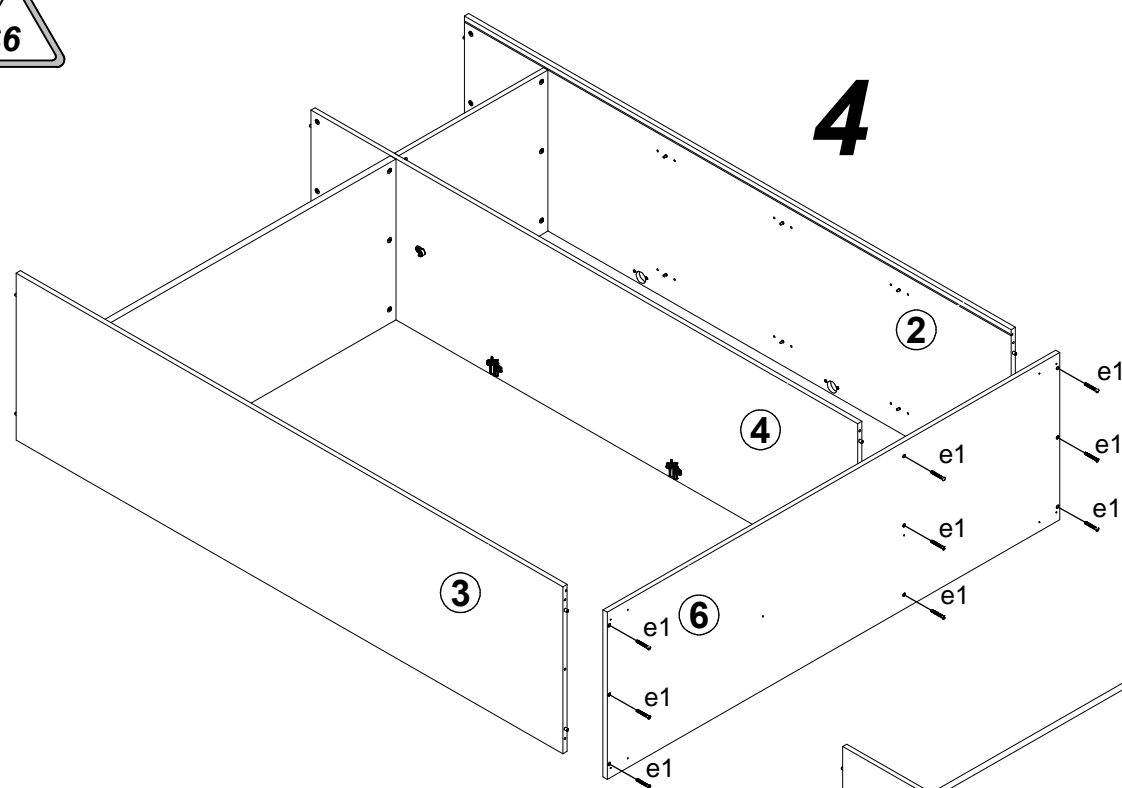
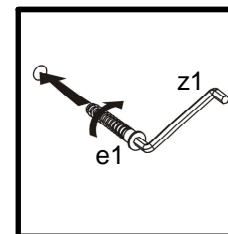



6

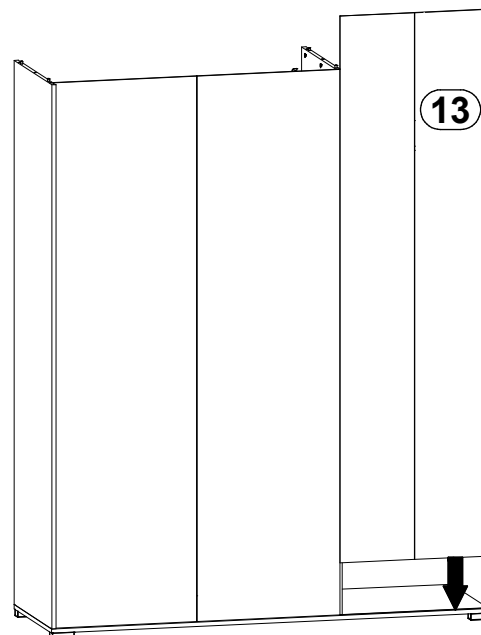
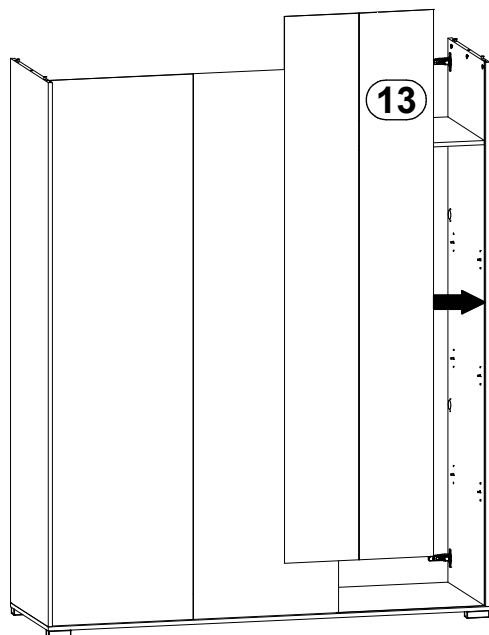
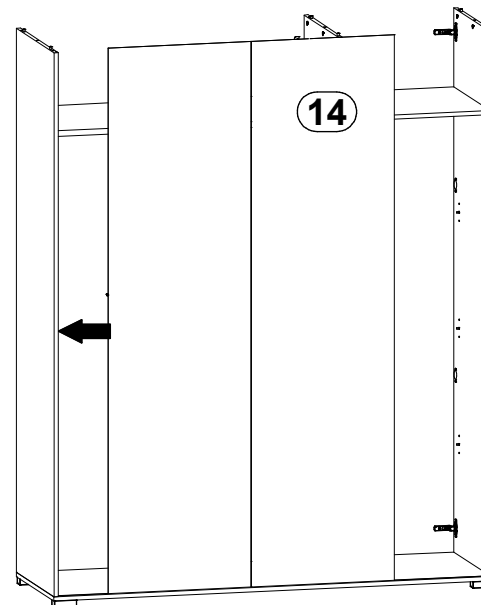
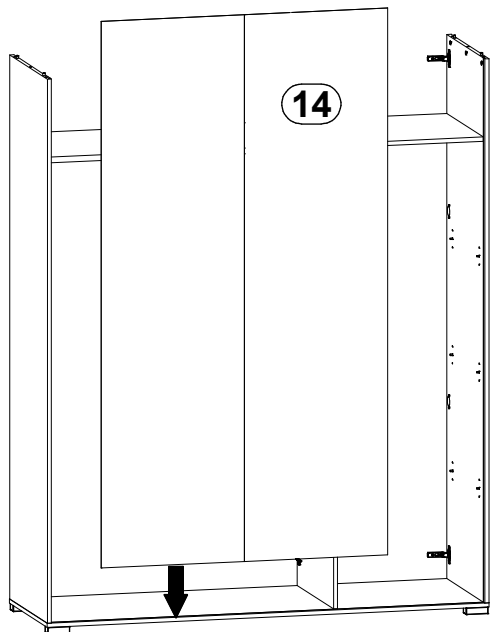



7

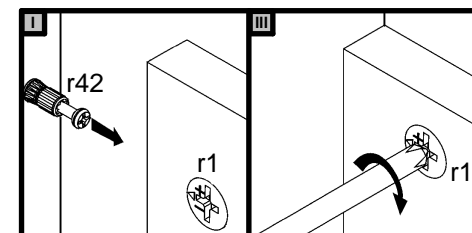
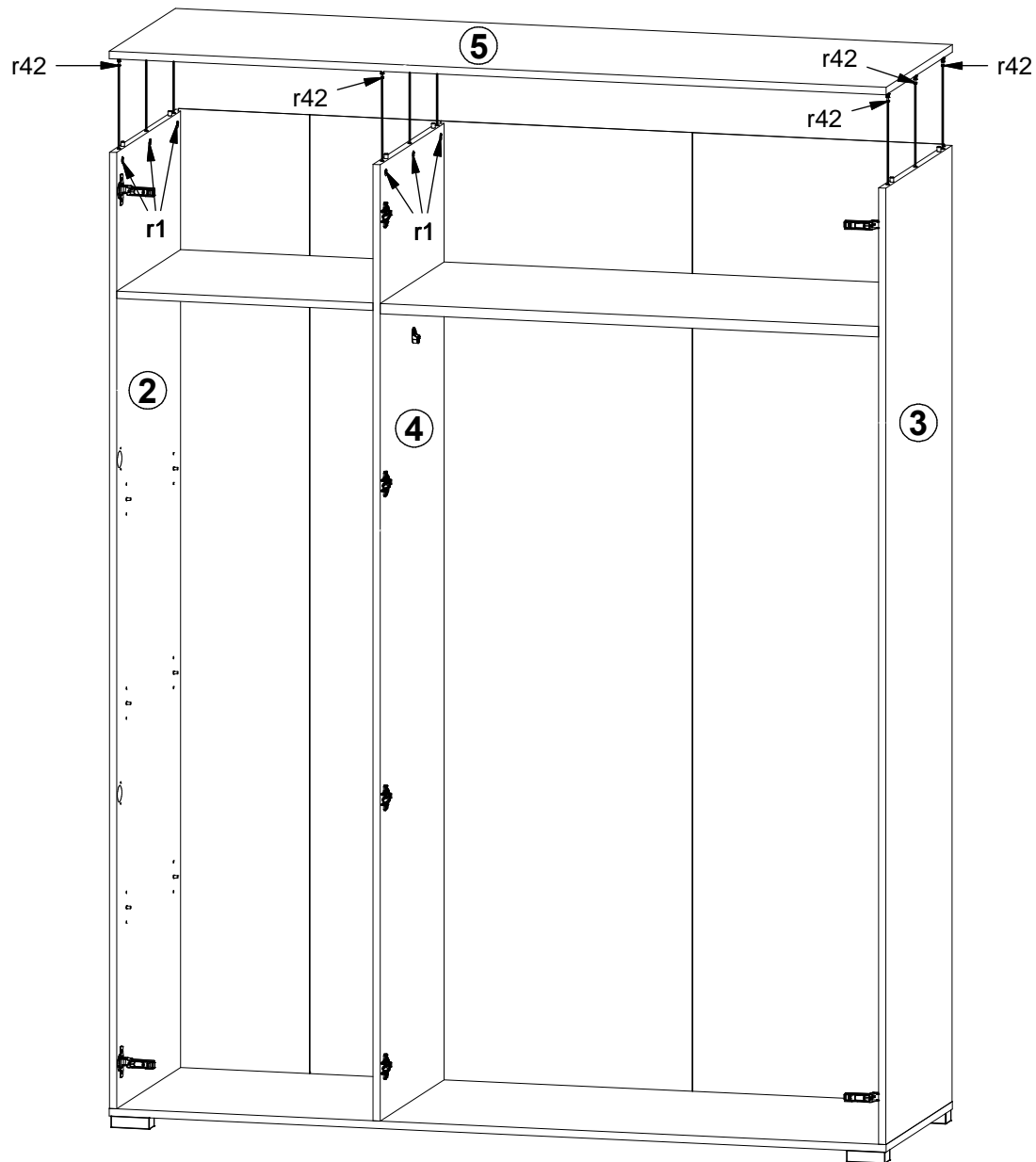

8

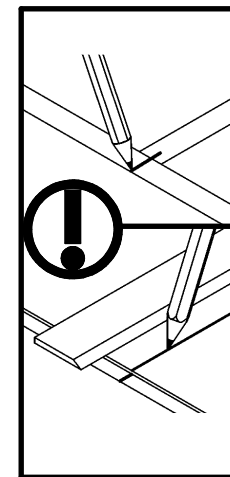
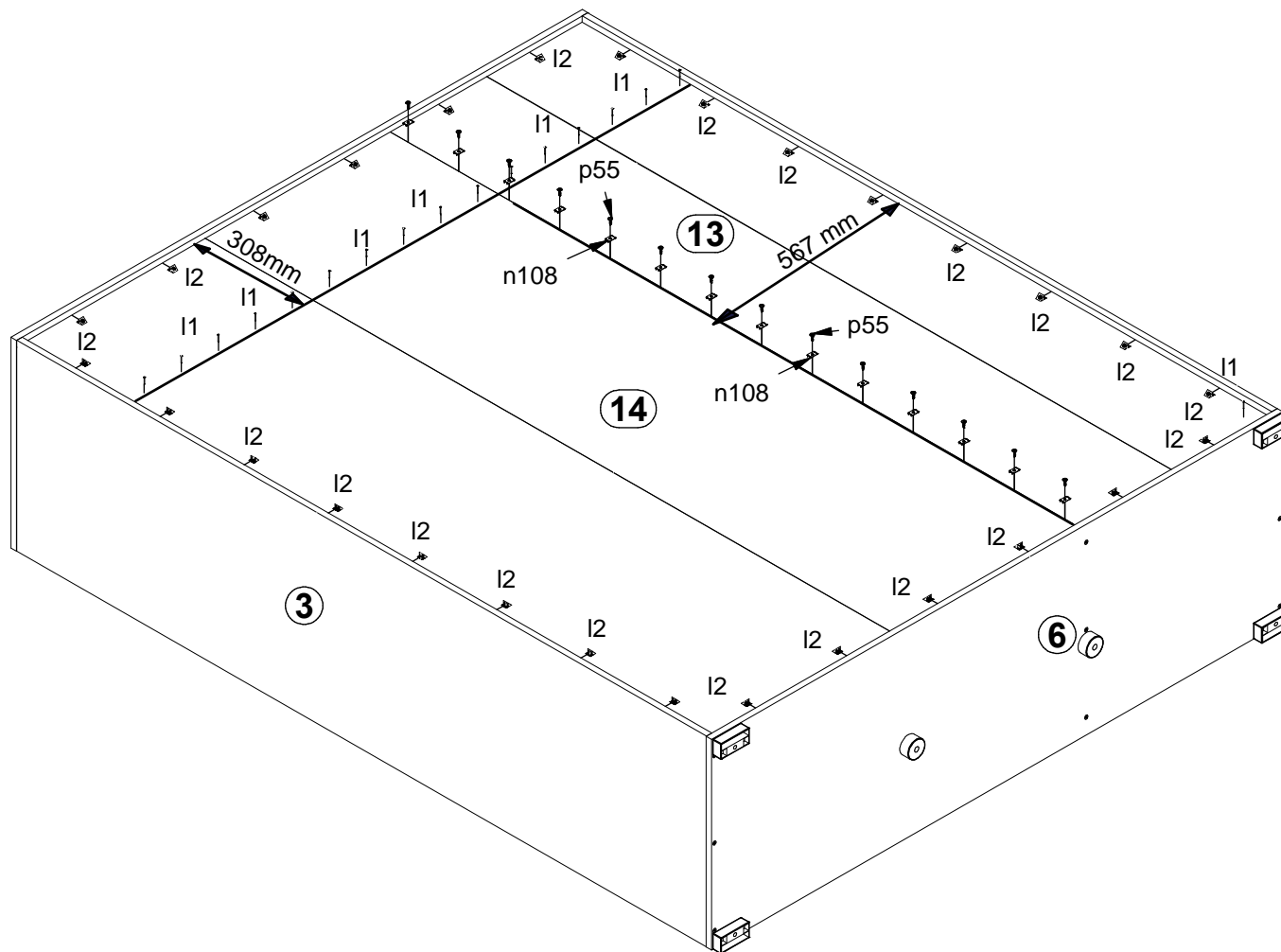
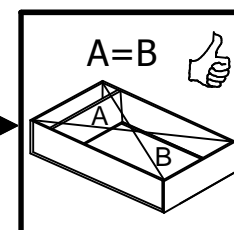
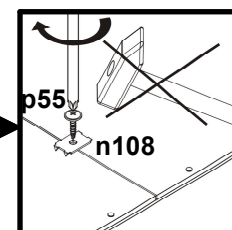
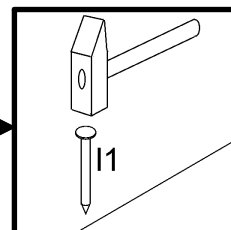
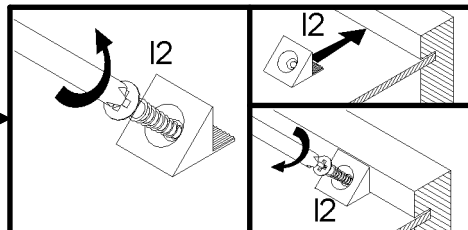
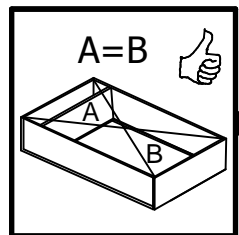

9

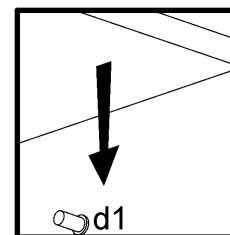
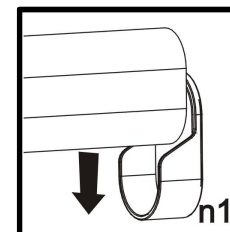
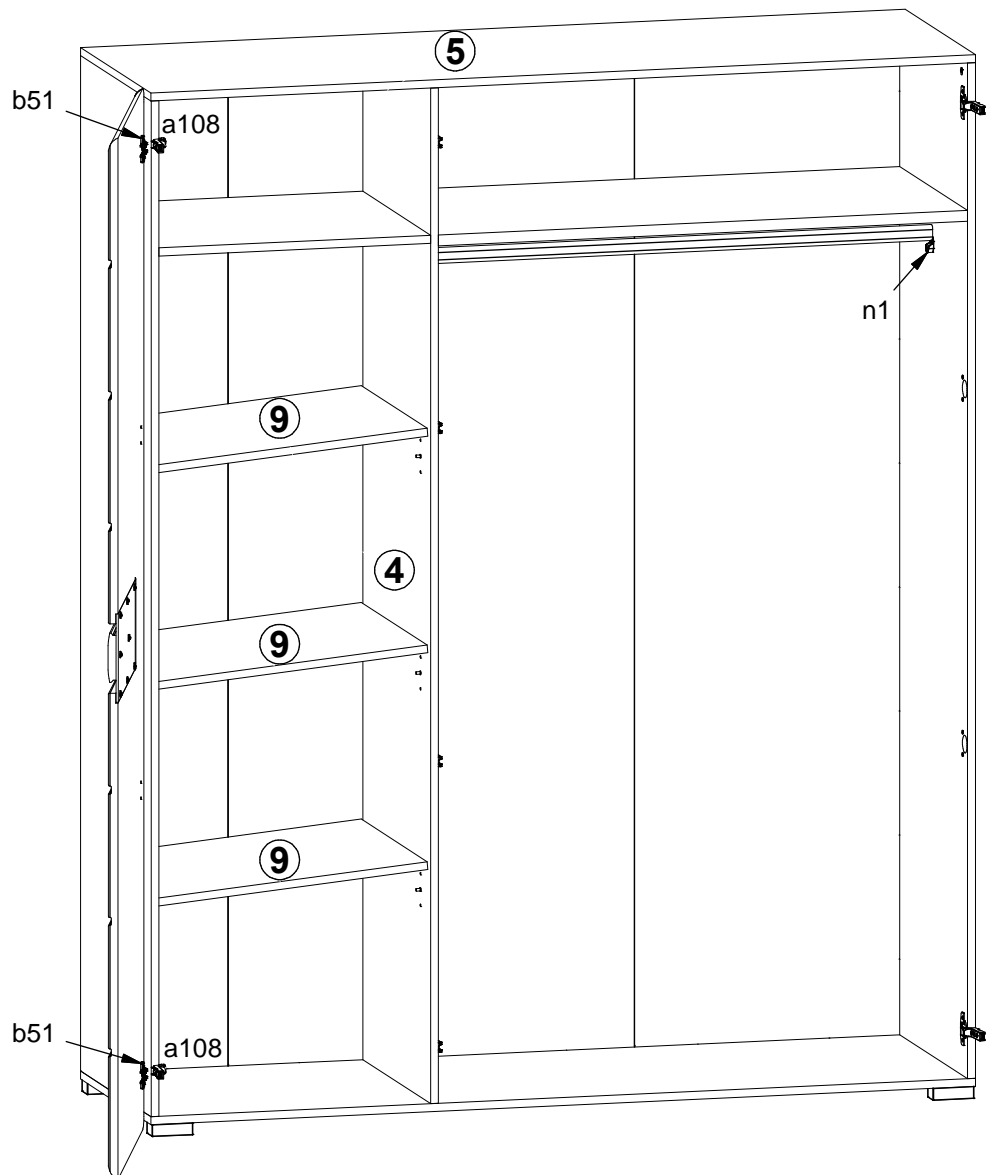
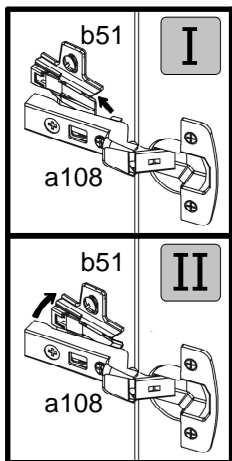

# 10

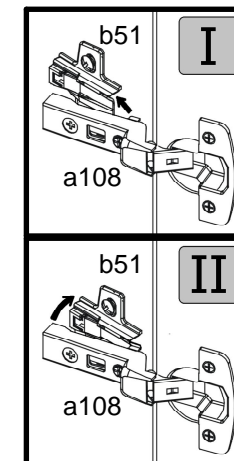
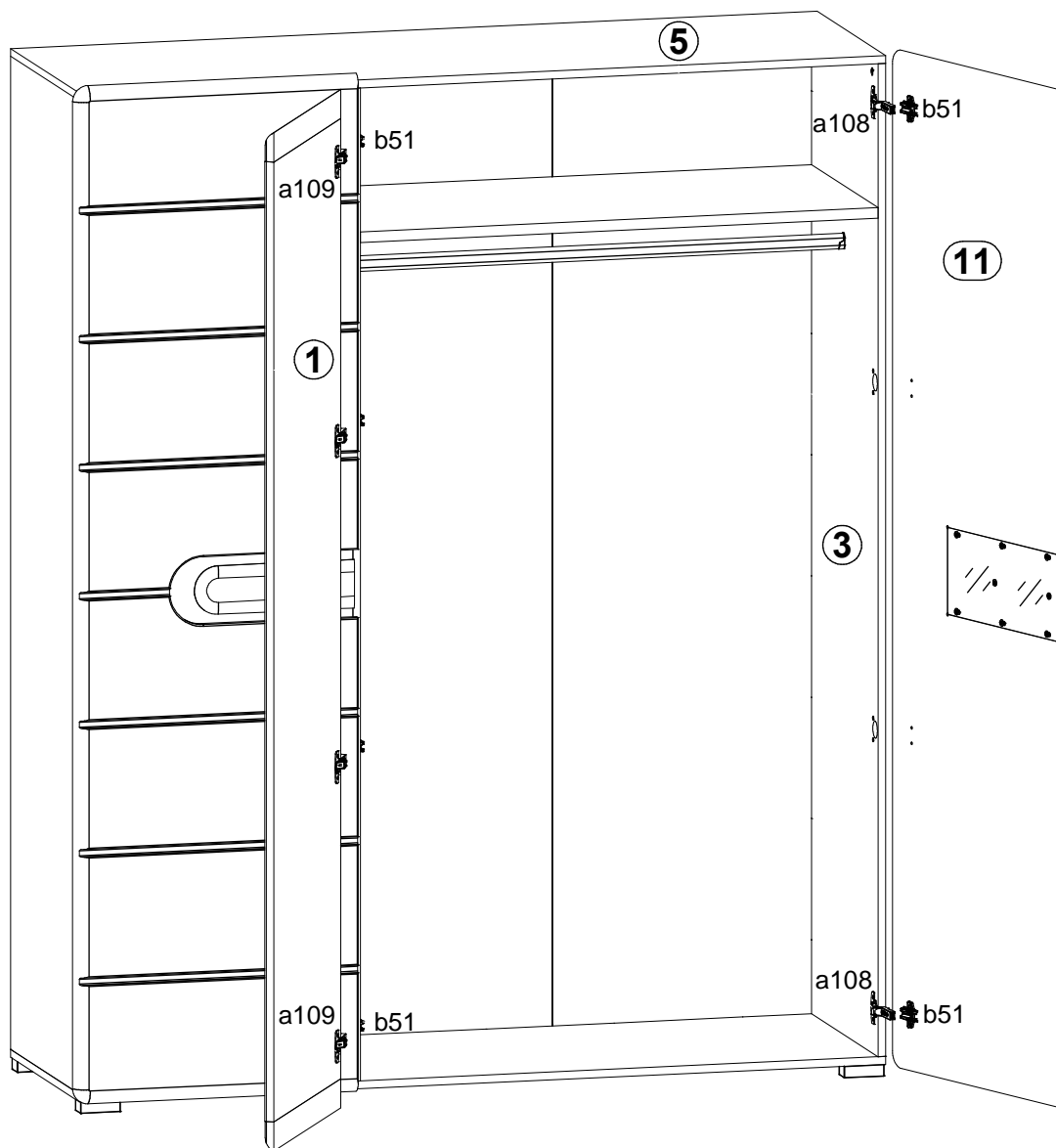
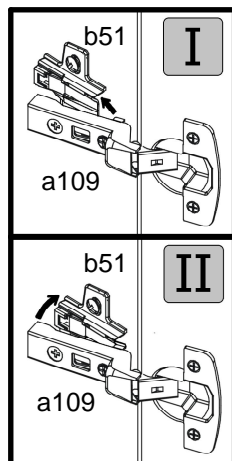

# 11

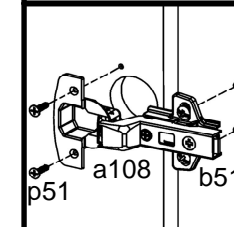
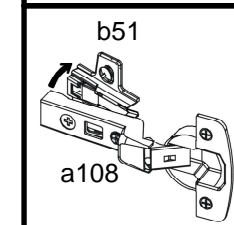
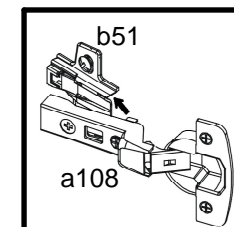
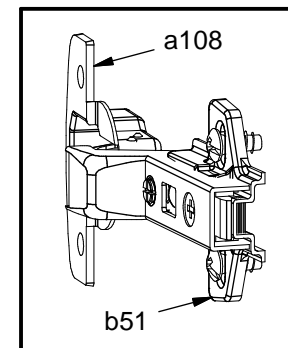
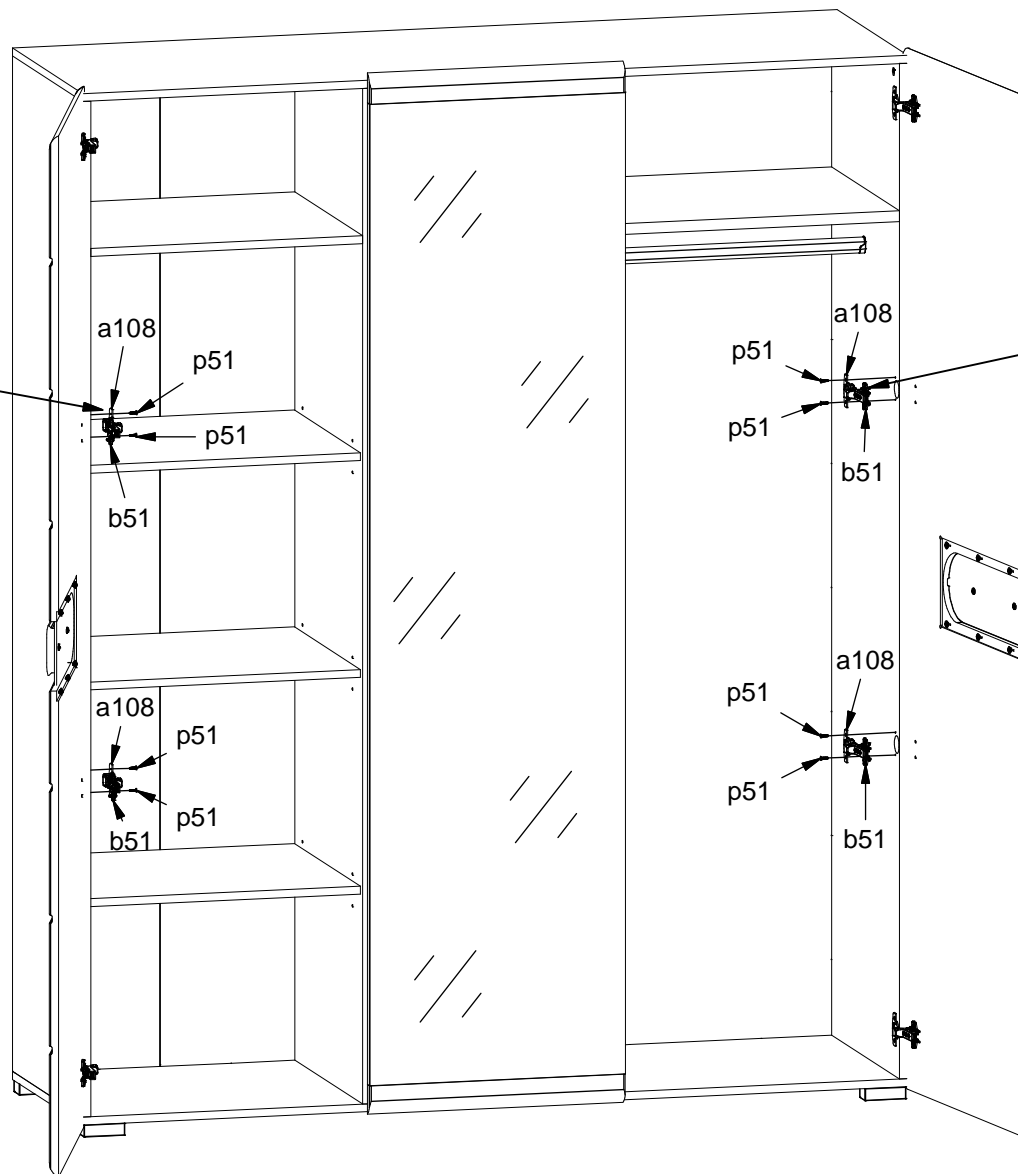
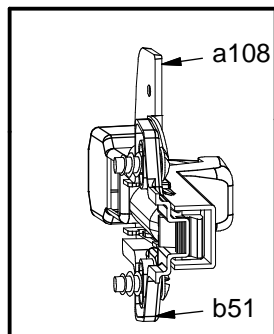

12

